

NO. 1-AC AIR COLLET FIXTURE

heinrich

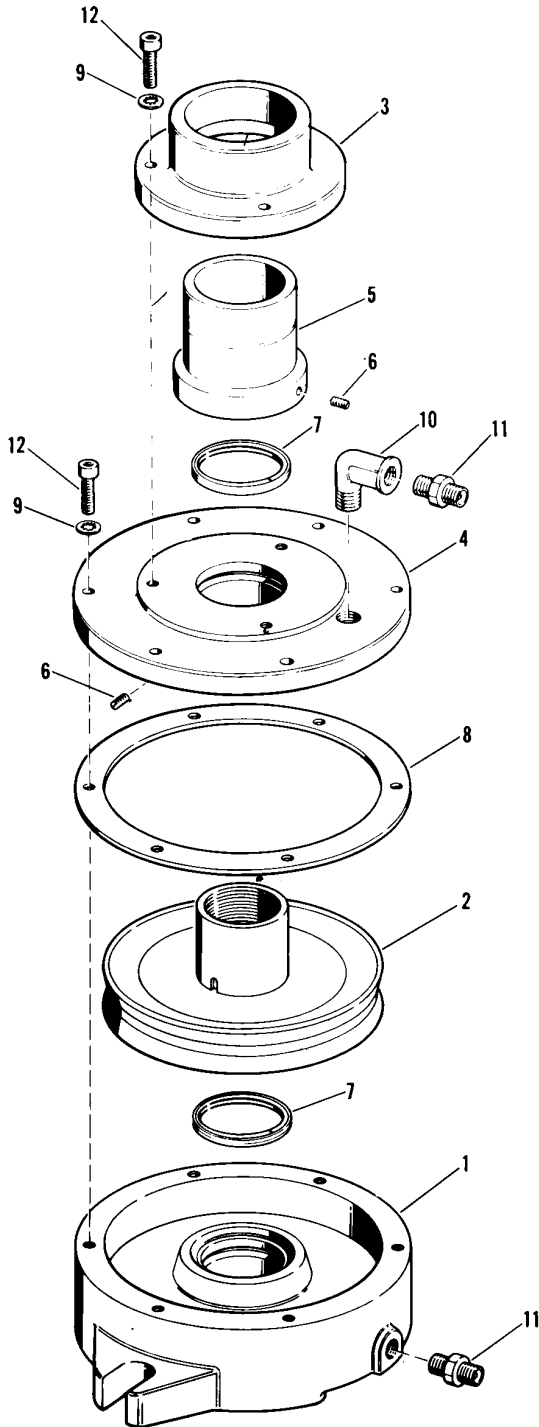

Index No.	Part Name	Part No.	Price
1	Base Casting	1AC-1	\$128.56
2	Piston Cup, with Draw Bar	1AC-2	143.75
3	Thrust Plate Casting	1AC-3	39.33
4	Cylinder Cover Casting	1AC-4	98.31
5*	Adapter	1AC-5	152.46
6	10-32 x 5/16 Socket Head Set Screw, full dog	1AC-6	2.18
7	3-part Ring (2 required)	1AC-7	26.14
8	Gasket	1AC-8	11.62
9	1/4 I.D. Internal Tooth Lock Washer (9 required)	1AC-9	0.58
10	Street Elbow	2200-33	4.72
11	Adapters (2 required)	33-16	3.19
12	1/4-20 x 7/8 Screw (9 required)	305-8	0.87

Recommended spare parts to be retained in stock at all times to support each unit in service: Index (7) G.T. Ring (6072)

*For gripping larger OD parts, Item 5 can be replaced with 1AC-5A, a \$84.00 add-on. The 1AC-5A adapter purchased separately is \$210.00. A step chuck collet and closer will also be needed, supplied by others.

OPERATION:

Connect one of the three identical hoses to the air supply line and to the adapter on the four-way valve marked "IN." Connect the other two hoses to the two adapters on the four-way valve marked "CYL" (cylinder) and to the two adapters on the collet fixture. To install 5-C collets, follow these instructions:

1. Loosen three (3) 1/4-20 socket head cap screws (12) on the painted thrust plate (3).
2. Place 5-C style collet in knurled adapter (5). Make sure keyway on outside of collet aligns with key in adapter (5).
3. Turn adapter (5) clockwise to close collet -- counter-clockwise to loosen. Adjust adapter (5) so collet has clearance for insertion of stock.
4. Tighten three (3) socket head cap screws (12) on thrust plate (3).
5. Center entire chuck for alignment before clamping to work table.

MAINTENANCE:

Disassemble as per exploded view. Clean and check each part for wear or damage. Replacement parts are available for immediate shipment from factory stock, or you may order through your local Heinrich distributor.

WHEN ORDERING PARTS, INDICATE PART NUMBER, MODEL NUMBER AND PRICE.